









### STRUTTURA

-  MATERIALE: metallo
-  FINITURA: nero opaco
-  INDOOR/OUTDOOR
-  PESO: 10,5 kg

### GRAFICA

-  MONOFACCIALE/BIFACCIALE
-  PERSONALIZZAZIONE

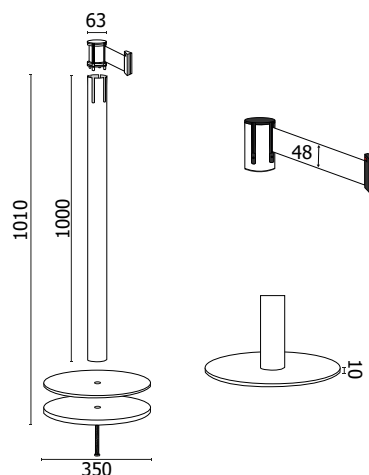

### NASTRO

-  MATERIALE: polipropilene
-  COLORE: rosso
-  COLORE: blu
-  COLORE: nero
-  COLORE: bianco
-  COLORE: verde
-  COLORE: giallo
-  COLORE: arancione
-  COLORE: bianco/rosso
-  COLORE: nero/giallo
-  COLORE: grigio

Colonnine Tendilinea con base piatta antinciampo e antiscivolo, montante in metallo con finitura nero opaco. Peso totale kg 10,5. Tappo superiore con tre clip riceventi e nastro in polipropilene di lunghezza 3 m con sistema autofrenante e clip di sicurezza, personalizzabile da entrambi i lati con logo ad 1 o più colori. Dotate di anello antiruggine in ABS nero per utilizzo interno ed esterno.

### DIMENSIONI PRODOTTO (mm)

Codice	Colore nastro	Dim. ØxH	Finitura colonnina	L nastro	Cod. EAN
<b>TEND002/R</b>	rosso	350x1010	nero opaco	3 metri	0768855758391
<b>TEND002/B</b>	blu	350x1010	nero opaco	3 metri	0768855758377
<b>TEND002/N</b>	nero	350x1010	nero opaco	3 metri	0768855758384
<b>TEND002/GN</b>	giallo nero	350x1010	nero opaco	3 metri	0768855758438
<b>TEND002/BR</b>	bianco rosso	350x1010	nero opaco	3 metri	0768855758421
<b>TEND002/BI</b>	bianco	350x1010	nero opaco	3 metri	0768855758414
<b>TEND002/V</b>	verde	350x1010	nero opaco	3 metri	0768855758407
<b>TEND002/AR</b>	arancio	350x1010	nero opaco	3 metri	0755899261710
<b>TEND002/GI</b>	giallo	350x1010	nero opaco	3 metri	0755899261727
<b>TEND002/GR</b>	grigio	350x1010	nero opaco	3 metri	0768855795662

### MISURE IMBALLO (mm/kg)

n. art. per imballo	Dim. imballo	Peso art.	Peso art. e imballo
2	390x1020x150	10,50	23,00