









**STRUTTURA**

-  MATERIALE0: acciaio
-  FINITURA: acciaio spazzolato
-  INDOOR/OUTDOOR
-  PESO: 10 kg

**GRAFICA**

-   MONOFACCIALE/BIFACCIALE
-  PERSONALIZZAZIONE

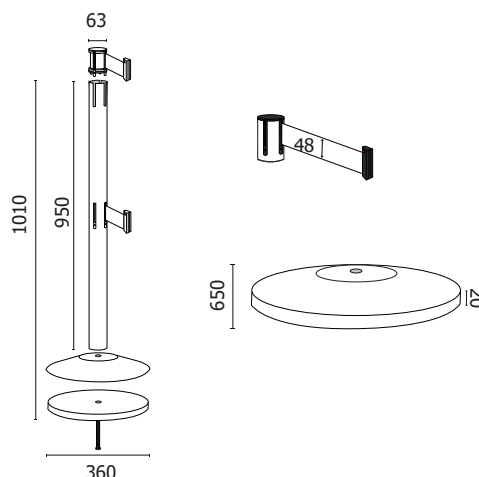

**NASTRO SUPERIORE**

-  MATERIALE: polipropilene
-  COLORE: rosso
-  COLORE: blu
-  COLORE: nero
-  COLORE: bianco
-  COLORE: verde
-  COLORE: giallo
-  COLORE: arancione
-  COLORE: bianco/rosso
-  COLORE: nero/giallo
-  COLORE: grigio

**NASTRO INFERIORE**

-  MATERIALE: polipropilene
-  COLORE: rosso
-  COLORE: blu
-  COLORE: nero

Colonnine tendinastro con finitura in acciaio spazzolato o nero opaco. Doppio nastro in polipropilene retrattile con sistema autofrenante lunghezza 3 mt con clip di sicurezza finale. Personalizzabile da entrambi i lati con logo ad 1 o più colori. Peso totale kg 10. Anello antiruggine in ABS nero per utilizzo interno ed esterno.

**DIMENSIONI PRODOTTO (mm)**





Codice	Dim. ØxH	Lunghezza nastro	Cod. EAN
STOP51D	360x1010	3 metri	0768855778443

**MISURE IMBALLO (mm/kg)**



n. art. per imballo	Dim. imballo	Peso art.	Peso art. e imballo
2	390x1020x150	10,00	22,00



**STRUTTURA**

-  MATERIALE: metallo
-  FINITURA: acciaio spazzolato
-  INDOOR/OUTDOOR
-  PESO: 10 kg

**GRAFICA**

-   MONOFACCIALE/BIFACCIALE
-  PERSONALIZZAZIONE

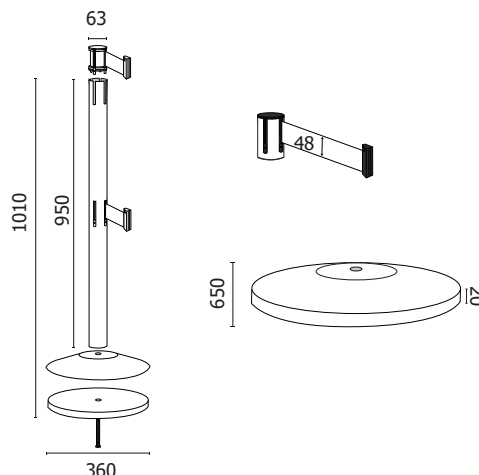

**NASTRO SUPERIORE**

-  MATERIALE: polipropilene
-  COLORE: rosso
-  COLORE: blu
-  COLORE: nero
-  COLORE: bianco
-  COLORE: verde
-  COLORE: giallo
-  COLORE: arancione
-  COLORE: bianco/rosso
-  COLORE: nero/giallo
-  COLORE: grigio

**NASTRO INFERIORE**

-  MATERIALE: polipropilene
-  COLORE: rosso
-  COLORE: blu
-  COLORE: nero

Colonnine tendinastro con finitura in acciaio spazzolato o nero opaco. Doppio nastro in polipropilene retrattile con sistema autofrenante lunghezza 3 mt con clip di sicurezza finale. Personalizzabile da entrambi i lati con logo ad 1 o più colori. Peso totale kg 10. Anello antiruggine in ABS nero per utilizzo interno ed esterno.

**DIMENSIONI PRODOTTO (mm)**

Codice	Dim. ØxH	Lunghezza nastro	Cod. EAN
STOP51DN	360x1010	3 metri	0768855785823

**MISURE IMBALLO (mm/kg)**

n. art. per imballo	Dim. imballo	Peso art.	Peso art. e imballo
2	390x1020x150	10,00	22,00